

# The Development of a Standard for Contact Transient Methods of Measurement of Thermophysical Properties<sup>1</sup>

R. P. Tye,<sup>2</sup> L'. Kubičár,<sup>3</sup> and N. Lockmuller<sup>2,4</sup>

---

Contact transient methods, some of which are available as commercial forms, are now widely used worldwide for thermal properties measurements on broad ranges of materials used in physical, chemical, and medical applications. However, in many cases the claimed measurement uncertainty has not been substantiated while in others – especially for the multiproperty techniques – internal inconsistencies in measured and/or derived values are clearly apparent. Following recommendations of participants of two workshops held on the subject in Würzburg (1999) and Cambridge, Massachusetts (2001), NPL agreed to coordinate a task to develop a standard test-method for these techniques. This involved using inputs provided by a small group of individuals from organizations in several European countries and also taking note of comments from other interested parties via the internet during the course of the development. Details are provided on the resulting document, which takes the form of a generic standard containing appropriate details and related information common to all techniques. These sections include the scope, theory, summaries of method, basic apparatus and experiment, the influencing factors, specimen requirements, procedure, and recommended approach for analysis of the experiment and calculation of the results. In addition, there are six annexes, each of which contains additional information that applies to a specific technique. Finally, the document proposes a recommended approach for verification of a technique together with a list of

---

<sup>1</sup> Paper presented as the Fifteenth Symposium on Thermophysical Properties, June 22–27, 2003, Boulder.

<sup>2</sup> National Physical Laboratory, Queens Road, Teddington, Middlesex TW11 0LW, United Kingdom.

<sup>3</sup> Institute of Physics SAS, Dubravská 9, 842 28 Bratislava, Slovakia.

<sup>4</sup> To whom correspondence should be addressed. E-mail: neil.lockmuller@npl.co.uk

appropriate reference materials having known values for one or more properties. The status of intercomparison studies will also be reported.

---

**KEY WORDS:** contact probe; contact transient method (CTM); diffusivity; effusivity; hot strip; hot wire; specific heat; standard; thermal conductivity; transient methods.

## 1. BACKGROUND

Heat transmission through materials is traditionally characterized by the basic partial differential equation for heat transport (heat equation) based on the Fourier law. This theory of heat transport was developed for homogenous materials and provides three parameters: thermal conductivity, specific heat, and thermal diffusivity. All three can be measured by individual techniques, and one test of validity (data consistency relation) for dense homogenous specimens is the relation between the measured parameters where thermal conductivity is the product of thermal diffusivity, specific heat, and density.

When no structural transformation exists, the physics behind these parameters is connected with phonons and electrons. Standard methods of measurement have been available for thermal conductivity, thermal diffusivity, and specific heat. In general, these have been based on the so-called steady-state or equilibrium techniques, which usually involve various large sizes or amounts of material as specimens and require especially long measurement times.

While most traditional materials have polycrystalline or amorphous structures, many of the more recently developed materials possess a combination of both (composites, layered structures, etc.), have a porous or multiphase structure, or are in very limited forms. From the physical point of view, such materials represent structures that are on the one hand in an equilibrium state and on the other hand in a highly nonequilibrium (metastable) state. Measurement techniques used for characterization of material properties are adjusted predominantly just as for traditional materials, and the current parameters have been suitable for such characterization.

The use of such materials has produced a broad spectrum of new issues and problems. The parameters used up to now do not necessarily represent the required measured properties, while the models used do not represent the processes being studied. This is a challenge for the physicist to build models of these sophisticated, highly inhomogeneous materials that should provide a minimum of reliable parameters. The development of measuring techniques is going hand in hand with the efforts to

verify the constructed models. In a majority of cases the thermal properties—thermal conductivity or diffusivity, heat capacity, and emissivity and/or absorption—are used up to now. However, the physics behind these parameters for the newer materials and their application is now an open question. Thus, the use of traditional parameters for the newer materials needs to be redefined and conditions for their application in practice need to be found.

The sheer volume of current materials and their applications, combined with their availability in limited sizes and forms only, make steady-state methods unsuitable for measurement requirements. There has been a growing need for the development of new methods that are more rapid, use smaller specimens, and are multiproperty in concept.

As a result, much attention has been paid to the development of the so-called contact transient methods (CTM) such that several commercial forms are already available and widely used. Table I summarizes the major forms of the methods, which are all based on this common principle. In addition, other variations of one or more of these techniques are in development.

Because of their apparent “simplicity” in concept and realization, these techniques have become very attractive and popular. In particular,

**Table I.** Summary of Basic Forms of Contact Transient Methods (CTMs)

Name of method	Heat source geometry	Way of heat production	Heat source/temperature sensor configuration	Measured and/or derived parameter <sup>a</sup>
Hot-wire/probe/strip	Line, strip	Step-wise	United <sup>b</sup> or separated <sup>c</sup>	$\lambda, a$ ( $c$ and $E$ in some experimental forms)
Pulse transient	Plane	Pulse	Separated	$a, c, \lambda$
Step-wise transient	Plane	Step-wise	Separated	$a, c, \lambda$
Hot plate transient	Plane	Step-wise	United	$E$
Hot disc transient	Disc	Step-wise	United	$a, c, \lambda$
Gustafsson probe	Concentric circles	Step-wise	United	$a, c, \lambda$

<sup>a</sup> $\lambda$  = thermal conductivity,  $a$  = thermal diffusivity,  $E$  = thermal effusivity,  $c$  = specific heat.

<sup>b</sup>one sensor.

<sup>c</sup>two sensors.

the fact that times of assembly and measurement are reduced from hours to minutes or seconds, and that specimen temperatures do not need to be controlled accurately for long periods of time, enables many specimens to be evaluated in the same time as one being evaluated by a standard technique, and makes them ideal for current requirements. One of the major attractions is that some are multiproperty in concept. Thus, the thermal diffusivity and heat capacity can be measured directly, often simultaneously, and hence thermal conductivity can be determined from the accepted relationship involving these properties and the density, i.e., automatic fulfillment of data consistency. Some more recent versions claim to enable all three properties to be determined directly from different parts of the temperature/time relationship(s). Furthermore, precision claims for these techniques are such that they are judged to be comparable to or better than standard methods. Also, the specimen temperature does not need to be controlled accurately for long periods of time. Finally, an important feature is that certain forms lend themselves to be considered as being suitable for "on-line" applications in manufacturing and processing or in miniaturized form for *in situ* and *in vivo* applications.

Due also to the significant advances that have occurred in instrumentation and computer hardware and software, it has been possible to automate fully each technique with results provided by an analysis using specialized, often proprietary software. Because of this factor, measurements are now often undertaken in many cases by operators having little direct experimental and/or materials experience who place reliance on the fact that the methodology realizes the solution of the appropriate model exactly and that the software represents this realization.

As these methods become more widely used, results of work on a number of homogeneous material types are becoming available from publications in fields of science and engineering. Examination of data indicates that the claimed high precision for one or another property by a particular technique (often 3% or better) is not substantiated since results for the same or similar material from two sources can differ by 10% and often more. Furthermore, in some cases results are often found to be internally inconsistent in that the measured thermal conductivity and/or that derived from thermal diffusivity and specific heat can be significantly different from the accepted value. In certain circumstances there are valid reasons, such as anisotropy, heat flow direction, convection, radiation, etc., why some differences in values for thermal conductivity can or may exist. However, they occur for materials or circumstances where none should exist and thus the particular method itself becomes of questionable use.

Recent examples to illustrate particular issues include measurements on Pyroceram 9606 using the hot-wire and Gustafsson-probe methods.

During the program of work for certification of Pyroceram 9606 thermal properties, some parallel-wire measurements were undertaken up to 1000°C on a specimen that was somewhat smaller than the recommended size. The results for this specimen are shown in Fig. 1, which also shows the reference values for the material obtained using standard guarded hot-plate and both resistive and parallel mode hot-wire tests on suitably larger specimens [1].

It can be seen that the directly measured thermal conductivity is significantly higher than the certified value and outside the expanded uncertainty. Furthermore, the derived thermal conductivity obtained from the individually measured thermal diffusivity and specific heat values exhibits much more scatter and irregularity. These results illustrate the importance of using test specimens that conform to the necessary criteria for a particular method.

The figure also contains results of measurements made up to approximately 380°C using the Gustafsson probe (transient plane source-TPS). The results are in good agreement with the certified values except for those for the higher temperature measurements, which are tending to diverge to higher values. The explanation appears to depend on the fact that a nickel sensor was used, and since nickel undergoes a transition in the region of 350°C, this could influence the results. It should also be mentioned that while the standard deviation for the individual thermal conductivity values was never greater than 3.5%, those for the heat capacity and thermal

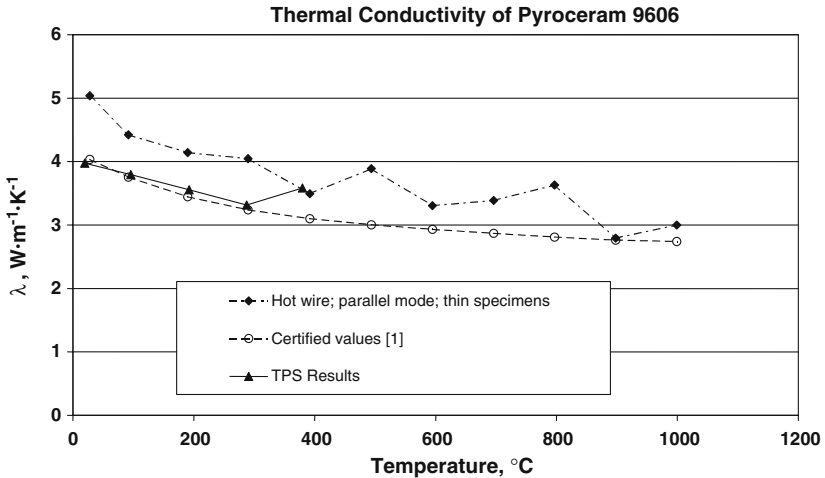


Fig. 1. Thermal conductivity of a thin Pyroceram 9606 specimen measured by hot-wire method in parallel mode.

diffusivity ranged from  $-4$  to  $+10\%$  indicating much more uncertainty in any derived values from these properties.

A further example relates also to the use of the Gustafsson probe on fluids and especially the influence of convection and contact resistance. Measurements were undertaken at room temperature on a silicone oil and on water and agar gel using both 6.4 and 3.3 mm diameter probes. The collected results are shown in Fig. 2a, b, which also contain values for the oil obtained by guarded hot-plate and transient hot-wire methods.

For the silicone oil, the effect of convection is quite apparent, and although the effect is reduced by use of a much smaller probe the effect remains of the order of 10 to 12%. A similar effect is seen with water but not with the agar gel, which has essentially the same thermal conductivity as water, thus confirming the effect is due to convection.

Measurements were also undertaken on ice in two ways, first with the probe sandwiched tightly between two blocks of ice with contact grease on the surfaces, and secondly by immersing the suspended probe in water and slowly freezing the system. The measured values were  $1.79$  and  $2.33 \text{ W} \cdot \text{m}^{-1} \cdot \text{K}^{-1}$ , respectively. The latter value compares very well with the literature value of  $2.38 \text{ W} \cdot \text{m}^{-1} \cdot \text{K}^{-1}$  at the same temperature [2] and indicates that there was little or no effect of contact resistance at the surfaces.

Clearly any such differences and uncertainties create serious problems for the scientist and engineer requiring “reliable data” for whatever material or application of concern. One means towards resolution of the problem is the development of an acceptable test methodology.

## 2. HISTORY OF DEVELOPMENT OF A STANDARD

Because of the worldwide use of these methods and the interests of so many workers, successive workshops addressing the subject have been held during the past three years in an attempt to resolve some of the issues and problems.

The first was organized by Ludovit Kubičár during the 14th European Conference on Thermophysical Properties (ECTP) in Würzburg, Germany in October 1999. The second was coordinated by Ronald Tye and Ludovit Kubičár at the 26th International Thermal Conductivity Conference (ITCC) in Cambridge, Massachusetts in August 2001. The last was held in London at the 16th ECTP in September 2002. In each case, some 40 to 50 attendees participated such that input was truly international.

Essentially the basic measurement procedure for these techniques is two-fold:

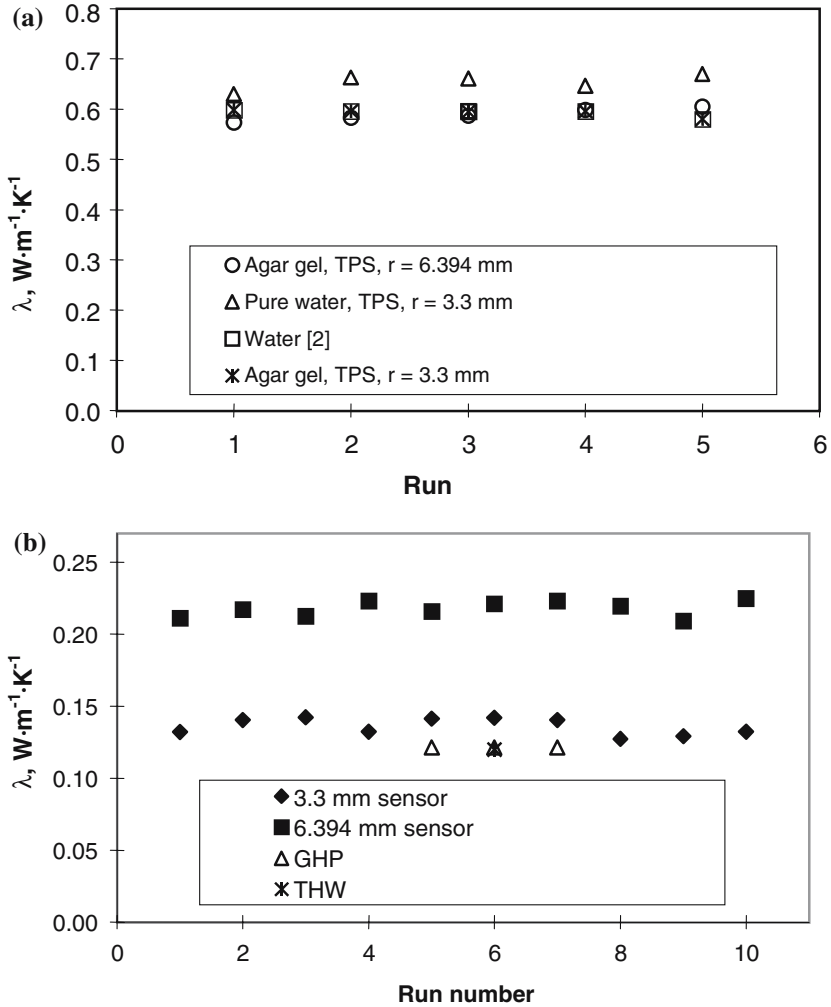


Fig. 2. (a) Thermal conductivity of agar gel and water measured using transient plane source method and (b) thermal conductivity of silicone oil by guarded hot-plate, transient plane source, and hot-wire methods.

1. Development of a model based on the common principle. This involves the solution of the partial differential equation for heat transfer in a specimen under selected or assumed initial and final boundary conditions.

2. Establishment of an experimental setup designed to represent the particular model together with a set of solutions that describes the measurement process and develops the measured property(s).

To provide reliable data, the experiment must represent the theoretical assumptions made in the development of the model. The measurement process involves the generation and subsequent mapping of a temperature field by a particular form of heat source (line, disc, strip, etc.) and deriving the thermal properties from the experimental data using the model. Essentially the major source of any discrepancy(s) is the degree to which the experiment does not truly represent the model. Compounding this issue is the matter of the validity of the model being representative of the actual situation and potential effects of external parameters.

At the first meeting, an attempt was made to present and discuss the basic issues represented by the above in order to:

- establish and prioritize the issues
- focus on means to address and resolve modeling and experimental issues
- formulate cooperation and coordination of effort

Although no overall solutions were obtained, a number of participants did agree to share interests and cooperate on some of the issues in order to develop some form of common approach. It was generally accepted that this could only be obtained by a collective and cooperative international approach towards some form of standardization.

The second meeting was much more focused and covered the following important issues:

- The variety of critical parameters that required consideration; in particular, adequate specimen size and geometry, the power level and time interval of the heat pulse, the time window for data analysis, contact resistances (both external and internal), and sensitivity to boundary conditions.
- The need for commercial equipment suppliers to be more aware of the many issues involved and to provide means to address them and to issue better and more comprehensive instruction manuals, especially for equipment based on “black boxes” containing closed software over which the user had no control for undertaking internal checks.



- The problems arising when combined heat transmission mechanisms are involved and direct relationships between thermal properties may not exist.
- The need for additional reference materials and the requirements for known or certified values of  $\lambda$ ,  $a$ , and  $c$ .
- Discussion concerning which organization or body (national or international) could or would be responsible for any standard(s) that may be produced.

The overall conclusions of the group were to:

- Continue initial objectives establishing an international network of experts.
- Produce a draft standard(s) covering measurement methods, using contact transient techniques and circulate it among the key workers in the field for comment and amplification. NPL, with the cooperation of Ludovít Kubičár, agreed to accept this task.
- Identify candidate reference materials covering a broad range of thermal properties appropriate for use with transient techniques and develop a test protocol for comparison testing.
- Organize a further Workshop at the 16th ECTP in London in 2002 to present and discuss the draft standard and associated issues.

During the period between the second and third Workshops, a first draft was prepared by the authors together with a number of inputs by experts involved in specific techniques. This was revised and refined and a second draft submitted for discussion at the meeting.

The document and its format as a generic main section combined with a number of annexes, each detailing a specific technique, provided a source of much discussion and agreement. However, the final consensus was that the effort should proceed and revised documents based substantially on the draft prepared for general submission to the thermophysics community via the NPL website (<http://www.npl.co.uk/>) with efforts to be made to introduce the document into both the international and national standards communities.

### 3. THE CTM STANDARD

Essentially the document takes the form of a generic standard containing the basic information common to the techniques obtained in Table I.

This is supplemented with a series of normative annexes, each containing the additional detailed information specific to an individual technique, particularly the scope, influencing factors, apparatus, and test specimen.

In general, the overall format of the generic document and accompanying annexes is that of an international standard (ISO) while being similar to that of various national standards. Thus, the contents consist of an Introduction, Scope, Referenced Documents, Terminology, Summary of Method, Significance and Use, Influencing Factors, Apparatus, Test Specimen, Procedure, Calculation of Properties, Verification of Method and Apparatus, Report, Precision and Bias and Bibliography. Brief details of each are provided but for reasons of space limitation only essential features of the generic document are presented. The annexes contain only relevant, similar information that is specific to a particular technique.

### 3.1. Scope

This states in broad detail the basic requirements of the family of methods that can provide one or more thermal properties obtained by analysis of the temperature/time response resulting from a heat pulse or heat flux in the form of a step-wise function generated within a specimen by some form of simple heat source. Overall this family of techniques can cover the range of thermal conductivity  $0.05 \text{ W} \cdot \text{m}^{-1} \cdot \text{K}^{-1} < \lambda < 200 \text{ W} \cdot \text{m}^{-1} \cdot \text{K}^{-1}$ , specific heat  $200 \text{ J} \cdot \text{kg}^{-1} \cdot \text{K}^{-1} < c < 2000 \text{ J} \cdot \text{kg}^{-1} \cdot \text{K}^{-1}$ , and thermal diffusivity  $0.01 \times 10^{-6} \text{ m}^2 \cdot \text{s}^{-1} < a < 10 \times 10^{-6} \text{ m}^2 \cdot \text{s}^{-1}$  in the temperature range  $200 < T < 1600 \text{ K}$ . However, reference is made to the annexes that contain the more limited ranges of properties and temperatures for each technique that apply and of the material types that can be investigated.

### 3.2. Referenced Documents

This section contains the relevant international and national standards applicable to this methodology.

### 3.3. Terminology

This is a complete list of terms and symbols that are used throughout the generic and annex documents.

### 3.4. Summary of Method

This section describes the essential features of the test, namely, that an appropriately sized rectangular or cylindrical specimen containing an

embedded simple geometric form of a low heat capacity heat source together with one or more combined or separate temperature sensors is allowed to equilibrate at a given temperature. An electrical current produces a heat pulse or heat flux in the form of a step-wise function in the electrical resistance (heat source) to generate a dynamic temperature field within the specimen. The temperature change with time (temperature response) is measured by a sensor(s), which is either unified with the heat source or placed a fixed distance from the source. The response is then analyzed in accordance with a model and set of solutions (temperature functions) developed for the representative setup and designed for the specific geometry and assumed boundary and initial conditions. Depending upon the geometry of the specimen and source and the means of the temperature field generation, one or more thermophysical properties can be obtained separately or simultaneously.

### 3.5. Significance and Use

This outlines the potential benefit of the methods including:

- Suitability for broad ranges of materials, temperatures, conditions, and environments
- Rapid assembly and measurement times coupled with relative simplicity of specimen configuration and measurement concept.
- Multiproperty in concept for essentially homogenous dense materials. However, it is pointed out that this gain in number of properties can result in a corresponding loss of accuracy in one or more properties.
- A detailed inspection of a material structure is possible where one specimen is measured by several techniques involving a broad range of dynamics of the temperature field from a high level (pulse transient) followed by a low one (step-wise) to a low intensity using a small change hot-plate transient (Gustafsson disc).

### 3.6. Influencing Factors

This section is a most important one since it draws attention to the major factors that influence the final precision of the various techniques and means to minimize the effects.

Two factors influence the accuracy of any transient method, namely, the measuring time during which the temperature field is developed inside a specimen and the geometry of the specimen and of the heat source since

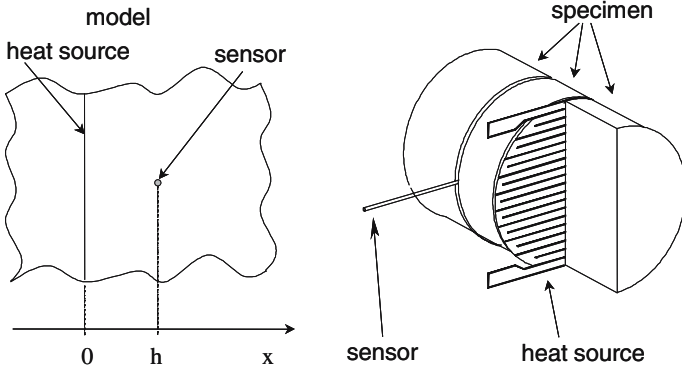


Fig. 3. Difference between ideal and real models for pulse transient and step-wise transient methods. Part of the specimen is cut out to see the structure of the heat source.

these limit the non-disturbed development of this temperature field. The optimal experimental setup requires a specimen size such that the temperature field generated by the heat source will not be disturbed during the time period when the temperature response is highly sensitive to the thermophysical properties of the tested materials. The essential criterion for accuracy is to have a non-disturbed temperature field from that generated by the heat source. Two deviations occur when the real model is compared to the ideal one due to the finite size of the specimen and the structure of the heat source being different from the real one. The ideal heat source has negligible thickness, the heat source should be made of the same material, and thermal contact between the specimen and heat source should be zero as shown in Fig. 3. The ideal model gives an optimum time for measurement and a maximum time window during which the evaluation can be made. This time window corresponds to the optimum overall sensitivity where the correlation between all the sensitivity coefficients is minimal.

From the methods shown in Table I, three basic forms of temperature fields exist as shown in Fig. 4. Simple symmetry of the temperature fields needs two probes to determine a complete set of thermophysical parameters. Three thermophysical parameters can be determined when a two-probe system (heat source and temperature sensor) is used for the line and the plane heat source and may also be determined for the disc source when a one-probe system is used. Generally, a one probe system parameter but with a more complicated symmetry will also provide all three properties using a single probe but the complicated symmetry puts much higher requirements on the control of the isotherm shapes. The generated temperature field is distorted by the heat source as illustrated in Fig. 5, contact

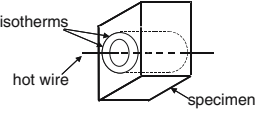
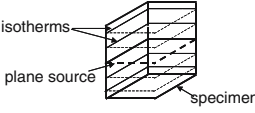
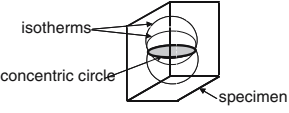
Line heat source	Plane heat source	Disc heat source
Hot wire	Pulse transient	Gustafsson probe
Hot strip	Step-wise transient	
Needle probe	Hot plate transient	
		
Shape of isotherms: concentric cylinders	Shape of isotherms: planes	Shape of isotherms: ellipsoids

Fig. 4. Symmetries of the temperature fields given by geometry of the heat source.

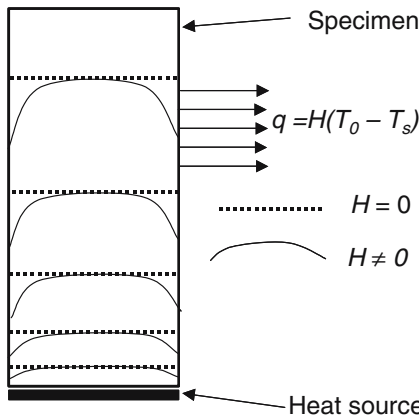
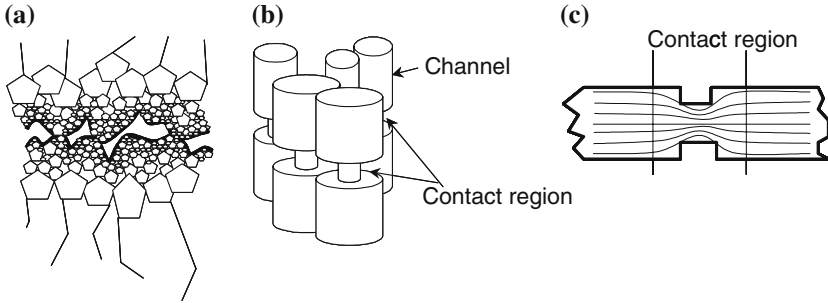


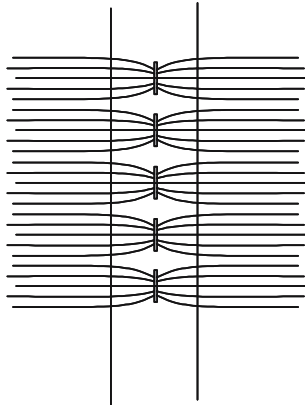
Fig. 5. Deformation of the temperature field for plane heat source and the specimen in the form of a cylinder:  $H$  – heat loss coefficient,  $T_s$  – specimen surface temperature, and  $T_0$  – surrounding temperature.

resistances (Figs. 6 and 7), and surface effects (Fig. 8), and thus there are deviations from the ideal model.

The experimental setup has to be designed such that the volume corresponding to the deformed temperature field is negligible compared to that corresponding to the non-disturbed field and also more sensi-

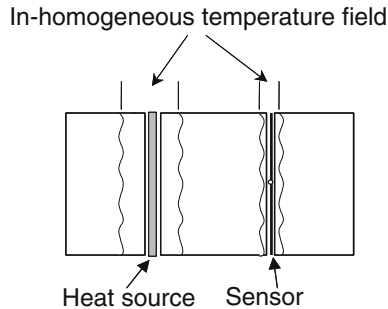


**Fig. 6.** Constriction resistance: (a) real contact of two bodies, (b) idealized model showing a set of flux tubes connected by conducting spots where the cross section of tubes and contacting spots are the same as those of two contacting bodies and of the contacting spots, respectively, and (c) contact region represents the tube volume corresponding to the deformed flux lines (deformed temperature field).



**Fig. 7.** Induced constriction resistance due to the structure of the heat source shown in Fig. 1.

tive to high flux regions such as the wire boundary. Generally the specimen volume corresponding to the deformed temperature field induced by thermal resistance is significantly larger in comparison to that caused by the constriction resistance. Figure 9 is one example in which this difference is illustrated by an experiment on Perspex. A difference analysis—as described in a later section—is used to obtain the time window as indicated by a period of data stability. The time window for the ideal model is limited by the sensitivity coefficient and, by correlation, while the cor-



**Fig. 8.** Deformation of the temperature field for heat source and sensor regions.

responding experimental time window is limited by the heat source effect at the beginning and the surface effect at the end.

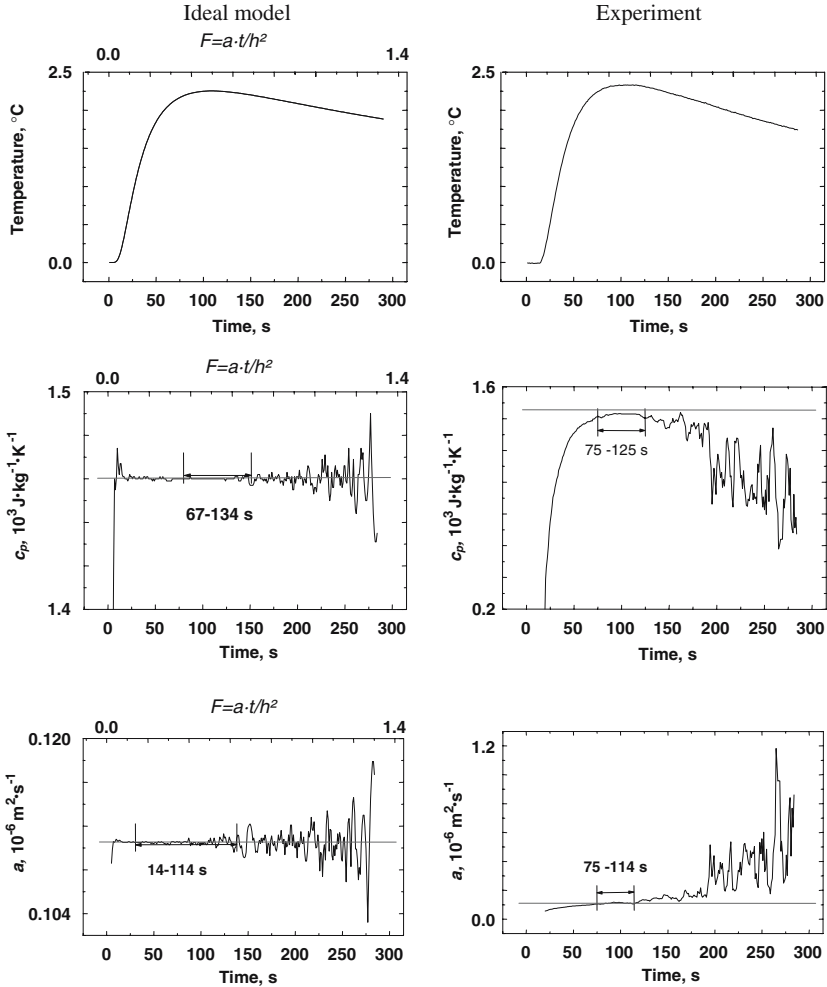
Other factors that can also affect the result include power levels for differing ranges of thermal properties and specimen sizes, the heat pulse time interval, and the heat flux in the form of a stepwise function by analysis of the temperature response. In addition, there are effects of specimen sizes and configurations, anisotropy of properties, and other heat transmission mechanisms that may be present. Other mechanisms that affect the validity of the basic assumption that all heat is transmitted by conduction include radiation, convection, and mass transfer.

### 3.7. Apparatus

This section contains the essential details of the experimental setup and the criteria for the ideal modes of the various techniques as shown schematically in Figs. 10 and 11, respectively.

Parameters described in detail include the various forms and configurations of the heat source and temperature sensors. Since it has been established that automated systems are to be used, recommended limits for lengths of test, recording times, frequency of data acquisition during the test run, limits of temperature rise, and resolution of temperature are provided.

For data analysis a fully automated data collection, analysis, and display system containing appropriate software is required to allow tests to be operated and the resultant transient curve to be analyzed in accordance with the temperature functions developed from the model. The fitting procedure used should be applied over the whole temperature response in order to obtain a large enough time window for a reliable fit. This window is dependent on various parameters including specimen properties and size, power level, and construction details of the power source and sensor. Means to evaluate optimum conditions are an essential requirement and



**Fig. 9.** Difference analysis results for pulse transient method comparing the ideal model and the experimental values (For Perspex specimen:  $\lambda = 0.192 \text{ W} \cdot \text{m}^{-1} \cdot \text{K}^{-1}$ ,  $a = 0.11 \times 10^{-6} \text{ m}^2 \cdot \text{s}^{-1}$ ,  $c = 1460 \text{ J} \cdot \text{g}^{-1} \cdot \text{K}^{-1}$ , and  $\rho = 1184 \text{ kg} \cdot \text{m}^{-3}$ ).

shall be included in the software to allow internal consistency to be assessed.

### 3.8. Test Specimen

Overall the methods can be used for a broad range of materials of widely different properties, but a particular method may be more appro-



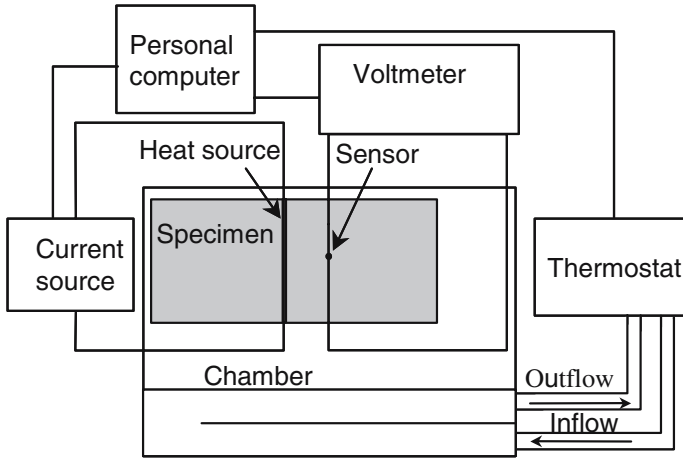


Fig. 10. Block diagram of the basic apparatus for contact transient methods.

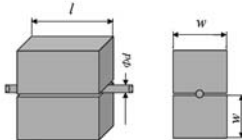
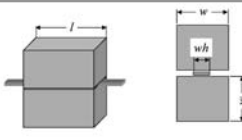
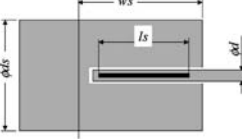
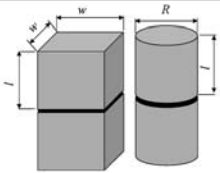
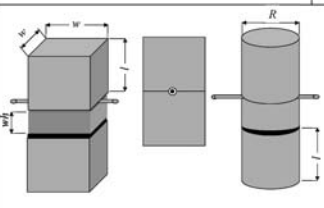
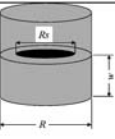
appropriate for a particular type size and form of material and/or range of thermal properties. Thus, a study of the model and its governing parameters is recommended to ensure that the most appropriate method is being used for the material to be tested.

It is particularly important to have a large enough specimen not only to ensure that it is suitable for the chosen method but also of sufficient size that the measured properties relate to the bulk material. As a minimum, the active specimen volume should be at least 10 times greater than the characteristic size of any component or inhomogeneity and also that surface effects should have zero effect on the measuring process.

Details are provided on containment of non-solid specimens, means to minimize contact resistances, and means to evaluate anisotropic materials; and a standard conditioning procedure is recommended.

### 3.9. Test Procedure

A detailed protocol is included to address the need for a reproducible test such that adequate comparisons of data obtained by these methods can be made. This addresses density and form prior to and following a test, ensuring the specimen is correctly assembled and contact resistances minimized, stability of temperature prior to and following a test, point application of power input, and recording of the resultant temperature curve. Recommendations are included for the number of repeat values, and ensuring stable system temperatures prior to repeat runs especially in cases where a change of physical state occurs. On completion of tests at the

Method	Specimen set-up	Characteristic parameters	Criteria of ideal model
Hot wire		$l$ – length $w$ – width $\Phi d$ – wire diameter	$200d < w$ $l > 4w$
Hot strip		$l$ – length, broad $w$ – width $wh$ – strip width	$200wh < w$ $l > 4w$
Needle probe		$ws$ – active zone $ls$ – needle probe length $\Phi d$ – needle probe diameter $\Phi s$ – specimen diameter	$ls > 100d$ $ws > 1.5ls$ $ds > 20d$
Hot plate		$w$ – width, broad $l$ – height $R$ – diameter	$w, l, R > 3\sqrt{at_{\max}}$ $a$ – thermal diffusivity $t_{\max}$ – maximal measuring time
Pulse and Step wise transient		$w$ – width, broad $l$ – height $R$ – diameter $wh$ – specimen thickness $H$ – surface heat loss coefficient.	$l > 1 \cdot wh$ $R, w > 5wh$
Gustafsson probe		$Rs$ – heat source diameter $R$ – specimen diameter $w$ – specimen thickness	$Rs - R > 5\sqrt{at_{\max}}$ $w > 2.5\sqrt{at_{\max}}$ $w > at_{\max}$ $t_{\max}$ – maximal measuring time



**Fig. 11.** Schematic illustration of various experimental models showing critical dimensions and the criteria for ideal modes of operation. <sup>1</sup>An appropriate groove or hole has to be made for the hot wire and needle probe, respectively. Good thermal contact must be assured (normally by use of a small amount of heat sink material); otherwise, the temperature field is disturbed. <sup>2</sup>Good thermal contact has to be made between the strip or disc and the specimen. There should be no heat sink compound outside the heater area; otherwise, the temperature field can be disturbed. Sufficient axial pressure is required to press the specimen and heater together.

highest temperature level, at least one repeat point is recommended on cooling.

### 3.10. Calculation of Thermal Properties

Two basic forms of temperature response (temperature rise versus time) are obtained depending on whether the response is generated by a heat pulse or a heat flux in the form of a step function.

Calculations of the thermophysical properties from the scans can be performed by fitting the corresponding temperature function in a chosen time window or from one point (it is the maximum of the temperature response) for the pulse transient method. Various calculation techniques are used to estimate the optimal time window as its choice is critical for data reliability. Depending on the model, some of these curves can be re-plotted against the logarithm of time or square root of time to make the analysis easier.

While various approaches can be used, a recommended one is a difference analysis based on a fitting of the temperature response over a selected small time interval in which the fitting procedure is applied successfully over the whole temperature response in order to obtain a large enough time window for a good fit. The valid time window is indicated by constant values of the thermophysical parameters over the entire time range. After eliminating any early and later scans of the temperature response, a time window as large as possible (middle period) should be obtained thereby ensuring that a large enough penetration depth has been attained. Figure 12 is an example of the schematic representation of the procedure for a specific method representing this technique. Other calculation techniques can be used providing their efficacy is demonstrated.

### 3.11. Verification

While these methods may, in general, be described as being “absolute” in that every effort has been made to base the experiment and its operation in accordance with a model approximating the ideal one, some

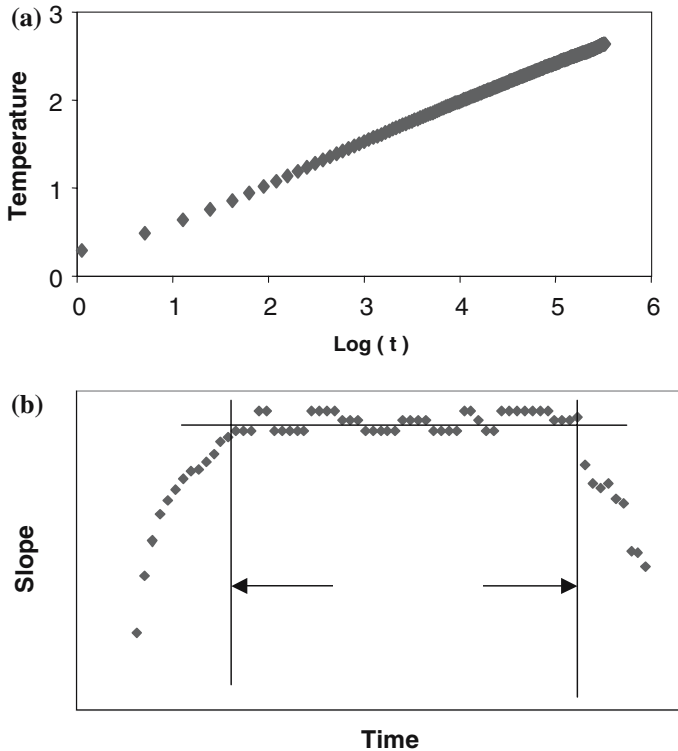


Fig. 12. (a) Temperature response as a function of log time and (b) result of a difference analysis of the temperature response.

uncertainties and inter-related effects may be present. Thus, it is recommended that all apparatus be verified by undertaking measurements on one or more reference materials available at the time. These can also be used to calibrate particular forms of a particular method, based on the use of a “known” specimen.

The present draft standard contains published data for some currently available materials having certified or accepted property values in the property range of the methods with an uncertainty of  $\pm 5\%$  or less. These are listed in Tables IIa–IIId. A strong request is included for additional suitable reference materials having all three properties known to within acceptable uncertainties to be made available in the future.

### 3.12. Report

This is a standard list of basic requirements concerning the material(s) and specimen tested, how the test was undertaken, how the apparatus was

Table II. Thermal Properties of Several Reference Materials

Temperature(°C)	Thermal conductivity (W · m <sup>-1</sup> · K <sup>-1</sup> )	Specific heat capacity (J · g <sup>-1</sup> · K <sup>-1</sup> )	Thermal diffusivity (10 <sup>-6</sup> m <sup>2</sup> · s <sup>-1</sup> )
(a) <i>Polymethylmethacrylate</i> (1180 to 1185 kg · m <sup>-3</sup> ) [3]			
0	0.188	1.267	
20	0.191	1.347	
40	0.193	1.428	
60	0.196	1.502	
70	0.198	1.549	
(b) <i>Pyrex 7740</i> (2220 to 2225 kg · m <sup>-3</sup> ) [3]			
0	1.10	0.720	
50	1.18	0.810	
100	1.24	0.878	
200	1.33	0.991	
300	1.45	1.082	
(c) <i>Pyroceram 9606</i> (2560 to 2600 kg · m <sup>-3</sup> ) [1]			
25	4.06	0.821	1.93
50	3.92	0.851	1.77
100	3.71	0.902	1.60
200	3.42	0.982	1.36
300	3.23	1.038	1.23
400	3.10	1.079	1.14
500	3.00	1.110	1.07
600	2.92	1.135	1.02
700	2.86	1.156	0.972
800	2.81	1.177	0.938
(d) <i>Other recommended materials</i>			
	Thermal conductivity (W · m <sup>-1</sup> · K <sup>-1</sup> )		
	Polydimethylsiloxane	Ottawa sand [5]	
	200 [4]	(1640 kg · m <sup>-3</sup> )	
20	0.160	0.28	
40	0.156	0.29	
60	0.152		
80	0.148		
100	0.144		

verified, the property values, and relevant details of experimental parameters used for the analysis.

### 3.13. Precision and Bias

Currently an interlaboratory study is in progress. This involves at least seven international organizations that use the Gustafsson probe method and also includes several organizations that use one or more of the other

techniques in order to evaluate the extent of possible agreement between techniques.

### 3.14. Bibliography

This is a list of over 30 representative publications on the various techniques. The intent is that it will be updated by and for interested parties.

## 4. SUMMARY

The present paper describes the needs for, and the historical development and contents of, a standard method of test using contact transient methods of measurement. This has been developed in accordance with the requirements and suggestions of workers in the thermophysical properties community. It is to be a continuing development, and it is hoped that international and national standards bodies will benefit from its availability.

## ACKNOWLEDGMENTS

The authors wish to express special thanks to Ulf Hammerschmidt, Silas Gustafsson, and Izaak van Haneghem for all of their help and support in this project.

## REFERENCES

1. D. R. Salmon, G. Roebben, and R. Brandt, "Certification of thermal conductivity and diffusivity up to 1000°C of Pyroceram 9606," in course of publication by IRMM, Geel, Belgium.
2. G. W. C. Kaye and T. H. Laby, *Handbook of Physical and Chemical Constants*, 16th Ed. (Longman Group, Harlow, Essex, 1995).
3. R. P. Tye and D. R. Salmon, in *Thermal Conductivity 25 Thermal Expansion 14*, Ralph B. Dinwiddie, ed. (DEStech Publications Inc., Lancaster, Pennsylvania, 2005), pp. 437–451.
4. Matthew James, John Redgrove, and Chris Brown, "Intercomparison of measurements of the thermal properties of liquid polymers for the processing industry," *NPL Report CBTLM S35* (National Physical Laboratory, Teddington, Middlesex, United Kingdom, 2000), pp. 41–43.
5. J. G. Hust and D. R. Smith, *NISTIR 89-3908*, National Institute of Standards and Technology, Boulder, Colorado (January 1989).